

# Data Sheet

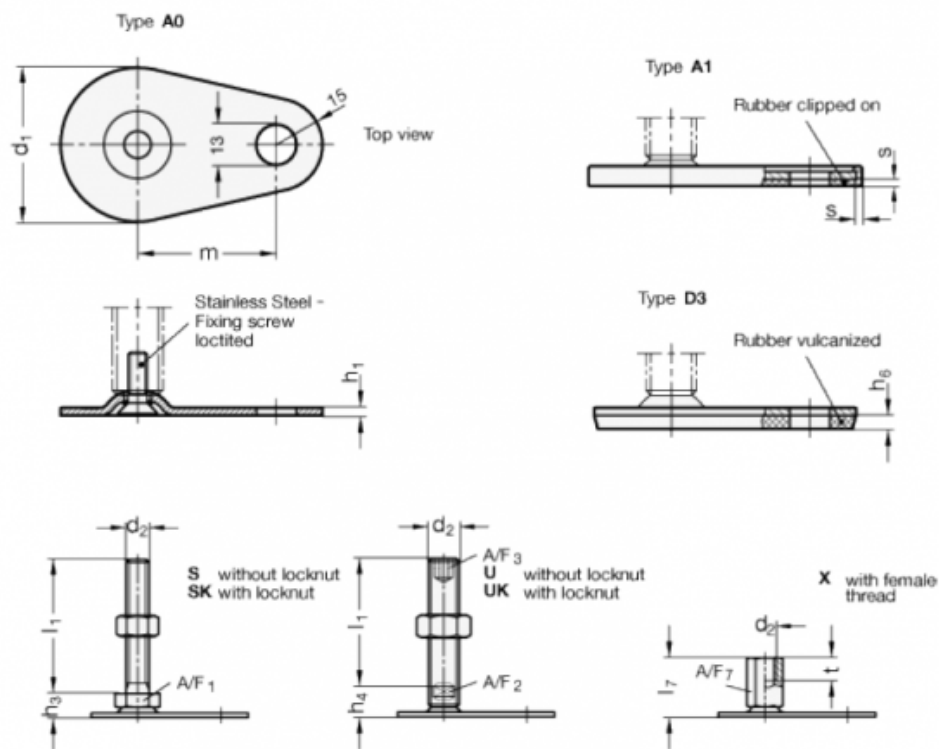

Article number: 204260M1637D3X  
 Description: E+G levelling foot  
 GN 42-60-M16-37-D3-X  
 Note: X With female thread, External hexagon

## Measures



A/F7 = 22	t = 16
d1 = 60	
d2 = M16	
h1 = 2.5	
h6 = 4.5	
l7 = 37	
m = 50	
s =	